

## Limited Warranty

HM DIGITAL

### ONE YEAR LIMITED WARRANTY

The PSC-54, including both the controller and sensor, is warranted by HM Digital, Inc. ("the Company") to the purchaser against defective materials and workmanship for one (1) year from the date of purchase.

**What is covered:** Repair parts and labor, or replacement at the Company's discretion. Transportation charges for repaired or new product to be returned to the purchaser.

**What is not covered:** Transportation charges for the defective product to be sent to the Company. Any consequential damages, incidental damages, or incidental expenses, including damages to property. This includes damages from abuse or improper maintenance such as tampering, wear and tear, water damage, or any other physical damage. The Company's products are not waterproof and should not be fully submerged in water. Products with any evidence of such damage will not be repaired or replaced. See additional note below.

**How to obtain warranty performance:** Attach to the product your name, address, description of problem, phone number, and proof of date of purchase, package and return to:

HM Digital, Inc.  
Los Angeles, CA USA  
310-410-3100

Contact Info: [info@HMDigital.com](mailto:info@HMDigital.com) / [www.HMDigital.com](http://www.HMDigital.com) / 1-800-383-2777

### [PANEL CUT-OUT SIZE DIAGRAM]

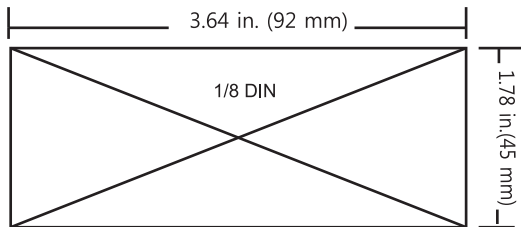

## USER'S GUIDE



## PSC-54



[www.HMDigital.com](http://www.HMDigital.com)

Ver 2.0

### [Display Temperature]

Press **CAL** + **UNIT MUTE** button simultaneously for 2 sec. in Regular mode to display temperature. Press **UNIT MUTE** button to select C/F. Press **ENTER SET** button to return to operations mode.

### [Setting Relay]

- Relay value will convert automatically according to Factor in each scale. Showing example applies to 150ppm.

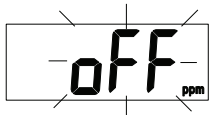

1. Press **ENTER SET** button for 2 sec.
2. With "off" display Press **UNIT MUTE** button once. "off" display will change to "on".

#### ► Press

**ENTER SET** with "off" when Relay is not in use.

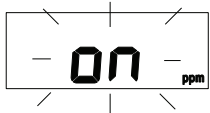

3. Red LED blinks when displaying "on"



4. Press **ENTER SET** to display the previously stored value



5. Press **CAL** button to reach desired value. Press and hold accelerates the process.

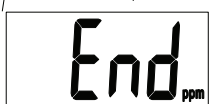

6. Press **ENTER SET** button shortly after set the desired value to save and return to Regular Mode with blinking "End" 3 times.

### [Mute Alarm]

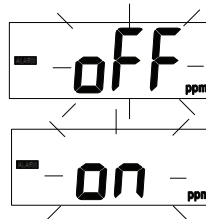

#### ► Mute Alarm Sound.

- Press **UNIT MUTE** button 2 sec. in operations Mode with blinking "off" 3 times. Alarm icon and Relay will show without alarm sound.
- Pressing button again to changes to "ON" - Relay resetting and Power ON/OFF returns to 'ON'.

### [Initializing]

#### ► Reset Relay Value

1. Press **ENTER SET** button for 2 sec. to enter the Setting Mode
2. With "on" or "off" displaying, Press **CAL** + **UNIT MUTE** buttons simultaneously for 3 sec. to display blinking "CLr" 3 times and return to operations mode.

#### ► Reset EC, TDS Calibration

1. Press **CAL** button for 5 sec. to enter the Calibration Mode.
2. Press **CAL** + **UNIT MUTE** buttons simultaneously for 3 sec. to return to operations Mode with blinking "CLr" 3 times.

#### ► Reset Temperature Calibration

1. Press **CAL** + **UNIT MUTE** buttons simultaneously for 2 sec. to enter the Temperature Mode.
2. Press **CAL** button for 5 sec. to enter the Calibration mode and Press **CAL** + **UNIT MUTE** buttons simultaneously for 3 sec.
3. With "CLr" blinks 3 times, returns to operations mode.

Thank you for purchasing HM Digital's PSC-54. The TDS/EC controller has a maximum set point to help maintain a limit of TDS/EC allowed in the water. If the TDS/EC level rises to the set point, the controller will activate an alarm and switch the relay. Once the TDS/EC level drops below the set point, this will deactivate the alarm and switch the relay contacts back to the normal position.

**[BOX CONTENTS]**

1. Controller with Mounting barcket
2. Sensor and Cable
3. Power cord and U.S. plug adapter
4. User's Guide

**[Specification]**

EC Range: 0~9999uS/cm / 0~20.00mS/cm  
 TDS Range: 0~9999ppm(mg/L) / 0~10.00ppt(g/L)  
 Resolution: uS & ppm: 0.1(0.0~99.9) , 1(100~9999), mS & ppt: 0.01  
 Accuracy: ±1.5% (FS)  
 ATC Range: Automatic (Temperature Compensation) 1~60°C  
 Calibration: Digital by push Button  
 Relay: 1 Point relay setting. Trigger relay when detects exceed value  
 Alarm: Beep sounds when exceed pre-set relay range (+Mute Function)  
 Analog Output: 4-20mA (Max load 500Ω)  
 Output Accuracy (mA): ±1.5%  
 Display: 2.3" LCD, Backlight function  
 Sensor: Single ABS sensor (1/2" NPTF bushing)  
 Cable: 3m(9.8ft) shielded cable  
 Power Supply: 110V/220V, ±10% VAC; 50/60Hz  
 Dimensions: 96 x 48 x 100 mm (3.8 x 1.9 x 3.9 in)  
 Monitor Weight: 261g (9.2 oz)

**[Display Festures]**

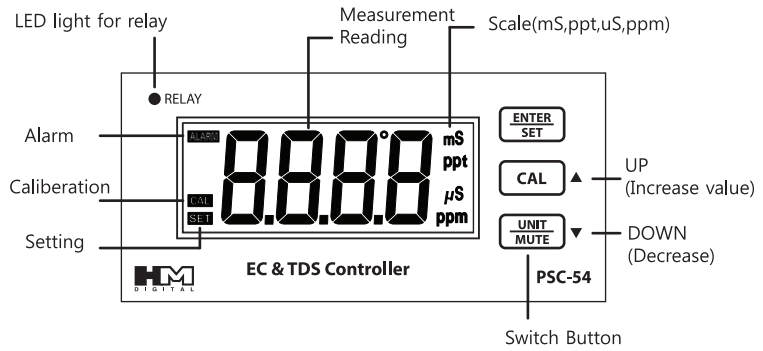

**[Back-Side]**

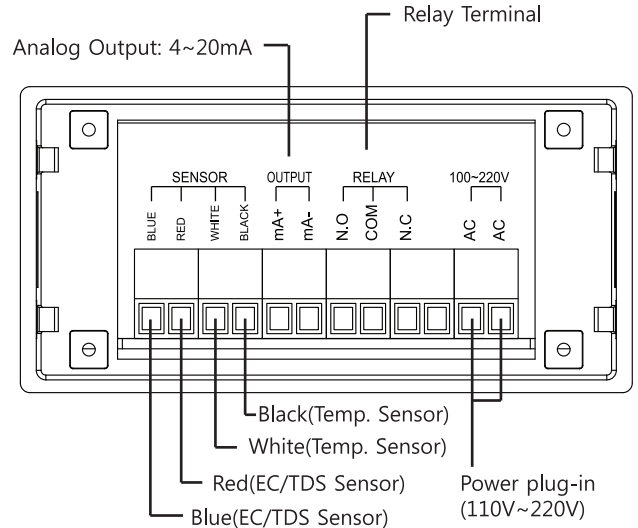

**[Installation]**

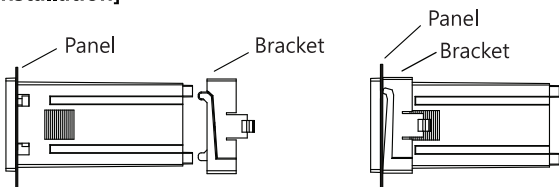

1. Remove Bracket by pulling tabs outward and slide off.
2. Place the product in designated space.
3. Insert the bracket to fix.
4. Insert sensors cable to matching colored terminal and tighten with flat-head screwdriver.
5. Opt. and connect relay method from N.O with COM or N.C with COM.
6. To transmit the TDS data to a PLC via the 4-20mA output signal, connect a cable (not included) from contacts mA+ (positive) & mA- (negative) to a PLC or other device.
7. Connect to 110V or 220V power source and then allow 3 min. of stabilizing period after initial power connect.

**[Setting Scale]**

- Press **[UNIT MUTE]** button after plug-in.
- Pressing button convert the scale from ppm -> mS -> ppt -> uS.

**[Calibration]**

- 3 min. of stabilizing period is required before calibration.
  - Prepare buffer-solution before calibration.
- There are two ways of calibration;
1. Calibrate with the water from actual pipe with sensor connected which has been measured with TDS or EC meter.
  2. Calibrate by submerging sensor in buffer-solution. Below direction uses 342ppm sample.



1. Choose ppm scale.
2. Press **[CAL]** button 5 sec.



3. 'CAL' and 'SET' icon will be blinking.
4. Press **[UNIT MUTE]** button to set the desired calibration value. (if hold the button, accelerates the value.)



5. Press **[ENTER SET]** after the desired value has been reached to display blinking 'CAL' icon and set value.

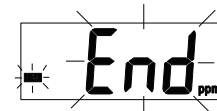

6. "End" icon blinks 3 times and the controller returns to operations mode after calibration.



7. Use the product after calibration.
- Calibration is possible at different scales.

**[Temperature Calibration]**

Press **[CAL]** + **[UNIT MUTE]** buttons simultaneously for 2 sec. to display temperature. Press **[CAL]** button for 5 sec. to display blinking 'CAL' and 'SET' icons. Press **[UP]** or **[DOWN]** button to set the desired temperature and Press **[ENTER SET]** button to store the value with "End" displaying.